

# FB

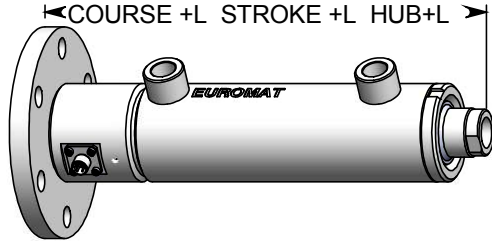

CEI.../...FB TT

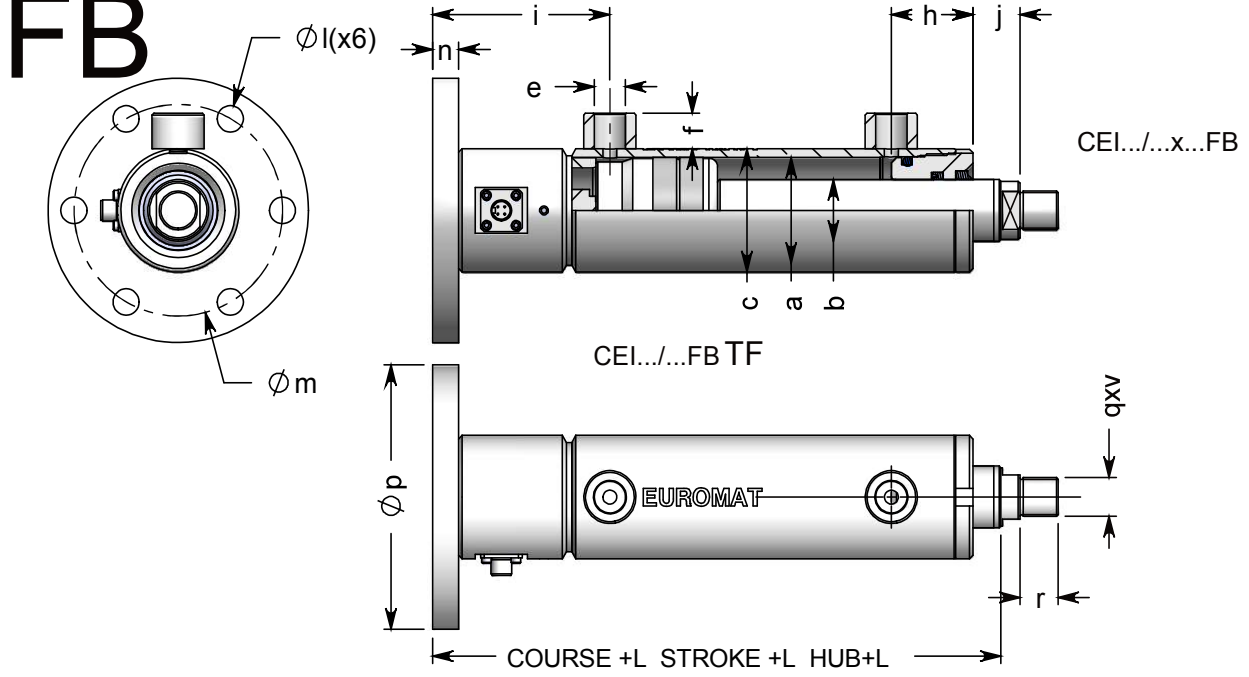
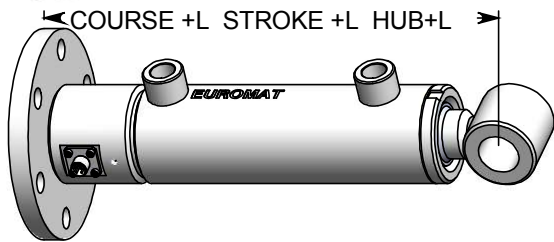
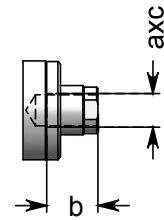
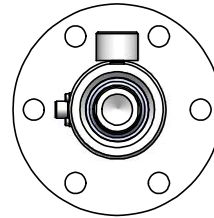

CEI.../...FB TO

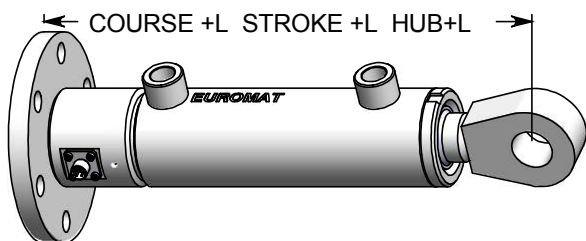
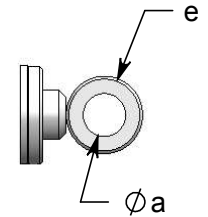
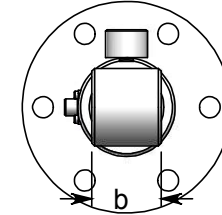

CEI.../...FB CM

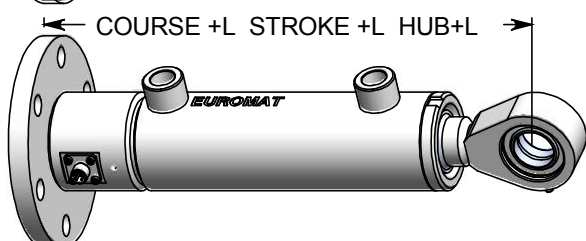
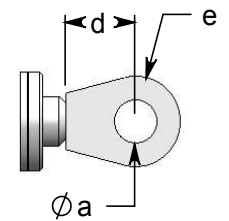
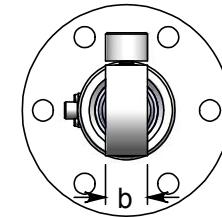

CEI.../...FB RO

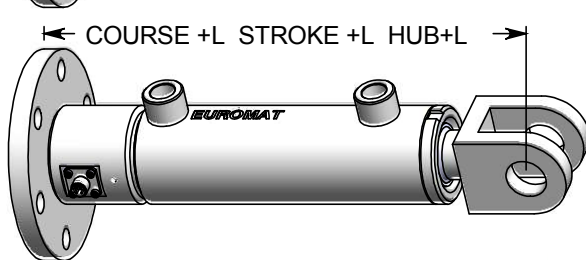
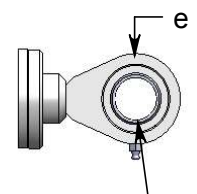
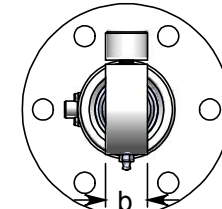

CEI.../...FB CF

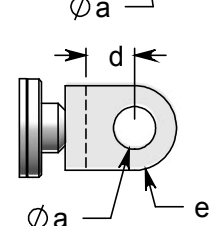
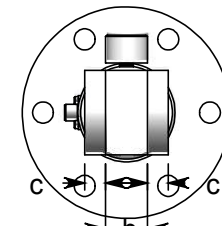

**EUROMAT**<sup>®</sup>

HENRION-HYDRAULIQUE S.A.S.  
Route de Corbie 80450 CAMON (AMIENS) FRANCE  
Tel : +33 (0)3 22 70 20 40 - Fax : +33 (0)3 22 70 20 49  
www.euromat.tm.fr / email : euromat@euromat.tm.fr

| CEI.../... FB TF | DONNEES TECHNIQUES |     |     |     | TECHNICAL SPECIFICATIONS |     |     |     | TECHNISCHE ANGABEN |     |     |  |
|------------------|--------------------|-----|-----|-----|--------------------------|-----|-----|-----|--------------------|-----|-----|--|
| a                | 60                 | 60  | 60  | 70  | 70                       | 80  | 80  | 100 | 100                | 125 | 125 |  |
| b                | 30                 | 35  | 40  | 35  | 40                       | 45  | 50  | 50  | 65                 | 65  | 80  |  |
| c                | 70                 | 70  | 70  | 80  | 80                       | 90  | 90  | 115 | 115                | 140 | 140 |  |
| e                | 3/8                | 3/8 | 3/8 | 3/8 | 3/8                      | 3/8 | 3/8 | 1/2 | 1/2                | 1/2 | 1/2 |  |
| f                | 20                 | 20  | 20  | 20  | 20                       | 20  | 20  | 20  | 20                 | 20  | 20  |  |
| g                | 0                  | 0   | 0   | 0   | 0                        | 0   | 0   | 0   | 0                  | 0   | 0   |  |
| h                | 47                 | 47  | 47  | 47  | 47                       | 50  | 50  | 60  | 60                 | 70  | 70  |  |
| i                | 34                 | 34  | 34  | 34  | 34                       | 34  | 34  | 34  | 34                 | 34  | 34  |  |
| j                | 19                 | 19  | 19  | 19  | 19                       | 16  | 16  | 20  | 20                 | 20  | 20  |  |
| l                | 15                 | 15  | 15  | 15  | 15                       | 15  | 15  | 21  | 21                 | 21  | 21  |  |
| m                | 120                | 120 | 120 | 130 | 130                      | 140 | 140 | 180 | 180                | 125 | 215 |  |
| n                | 15                 | 15  | 15  | 15  | 15                       | 15  | 15  | 20  | 20                 | 25  | 25  |  |
| p                | 150                | 150 | 150 | 160 | 160                      | 170 | 170 | 220 | 220                | 250 | 250 |  |
| q                | 22                 | 22  | 22  | 28  | 28                       | 35  | 35  | 45  | 45                 | 58  | 58  |  |
| r                | 22                 | 22  | 22  | 28  | 28                       | 35  | 35  | 45  | 45                 | 58  | 58  |  |
| v                | 1,5                | 1,5 | 1,5 | 1,5 | 1,5                      | 1,5 | 1,5 | 1,5 | 1,5                | 1,5 | 1,5 |  |
| L                | 245                | 245 | 245 | 245 | 245                      | 250 | 250 | 240 | 240                | 265 | 265 |  |

| CEI.../... FB TT |   |     |     |   |     |     |     |   |     |   |     |
|------------------|---|-----|-----|---|-----|-----|-----|---|-----|---|-----|
| a                | 0 | 24  | 24  | 0 | 24  | 30  | 36  | 0 | 45  | 0 | 52  |
| b                | 0 | 40  | 40  | 0 | 40  | 50  | 65  | 0 | 85  | 0 | 90  |
| e                |   | 2   | 2   |   | 2   | 2   | 2   |   | 3   |   | 3   |
| L                | 0 | 245 | 245 | 0 | 245 | 250 | 250 | 0 | 240 | 0 | 265 |

| CEI.../... FB TO |      |      |      |      |      |     |     |     |     |     |     |
|------------------|------|------|------|------|------|-----|-----|-----|-----|-----|-----|
| a                | 30   | 30   | 30   | 30   | 30   | 35  | 35  | 40  | 40  | 50  | 50  |
| b                | 50   | 50   | 50   | 50   | 50   | 60  | 60  | 80  | 80  | 90  | 90  |
| e                | 27,5 | 27,5 | 27,5 | 27,5 | 27,5 | 30  | 30  | 35  | 35  | 45  | 45  |
| L                | 270  | 270  | 270  | 270  | 270  | 280 | 280 | 275 | 275 | 310 | 310 |

| CEI.../... FB CM |     |     |     |     |     |     |     |     |     |     |     |
|------------------|-----|-----|-----|-----|-----|-----|-----|-----|-----|-----|-----|
| a                | 30  | 30  | 30  | 30  | 30  | 35  | 35  | 40  | 40  | 50  | 50  |
| b                | 30  | 30  | 30  | 30  | 30  | 35  | 35  | 40  | 40  | 50  | 50  |
| d                | 50  | 50  | 50  | 50  | 50  | 60  | 60  | 70  | 70  | 85  | 85  |
| e                | 32  | 32  | 32  | 32  | 32  | 40  | 40  | 47  | 47  | 60  | 60  |
| L                | 295 | 295 | 295 | 295 | 295 | 310 | 310 | 310 | 310 | 350 | 350 |

| CEI.../... FB RO |     |     |     |     |     |     |     |     |     |     |     |
|------------------|-----|-----|-----|-----|-----|-----|-----|-----|-----|-----|-----|
| a                | 30  | 30  | 30  | 30  | 30  | 35  | 35  | 40  | 40  | 50  | 50  |
| b                | 30  | 30  | 30  | 30  | 30  | 35  | 35  | 40  | 40  | 50  | 50  |
| d                | 50  | 50  | 50  | 50  | 50  | 60  | 60  | 70  | 70  | 85  | 85  |
| e                | 32  | 32  | 32  | 32  | 32  | 40  | 40  | 47  | 47  | 60  | 60  |
| L                | 295 | 295 | 295 | 295 | 295 | 310 | 310 | 310 | 310 | 350 | 350 |

| CEI.../... FB CF |     |     |     |     |     |      |      |     |     |     |     |
|------------------|-----|-----|-----|-----|-----|------|------|-----|-----|-----|-----|
| a                | 30  | 30  | 30  | 30  | 30  | 35   | 35   | 40  | 40  | 50  | 50  |
| b                | 30  | 30  | 30  | 30  | 30  | 35   | 35   | 40  | 40  | 50  | 50  |
| c                | 15  | 15  | 15  | 15  | 15  | 17,5 | 17,5 | 20  | 20  | 25  | 25  |
| d                | 35  | 35  | 35  | 35  | 35  | 43   | 43   | 50  | 50  | 63  | 63  |
| e                | 32  | 32  | 32  | 32  | 32  | 40   | 40   | 47  | 47  | 60  | 60  |
| L                | 295 | 295 | 295 | 295 | 295 | 315  | 315  | 310 | 310 | 358 | 358 |