

RO

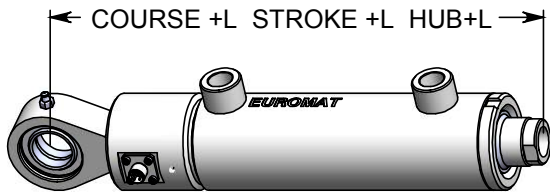

CEI.../...RO TT

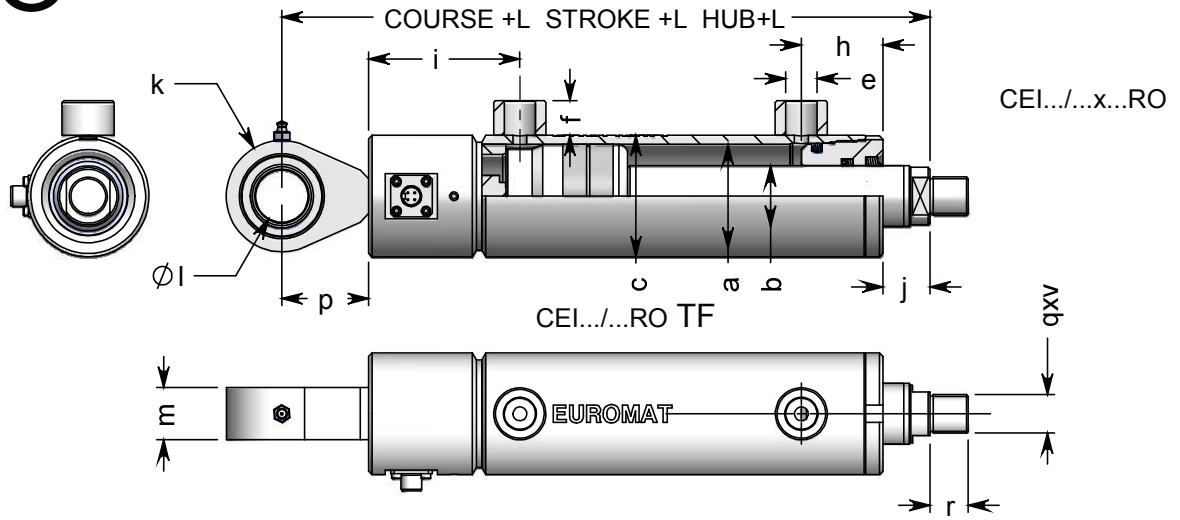
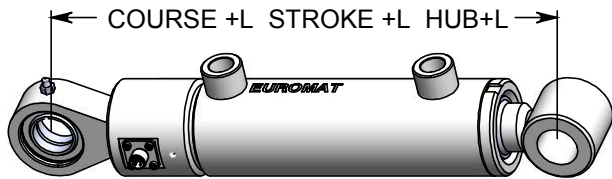
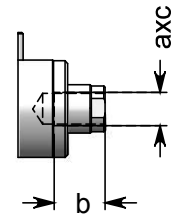
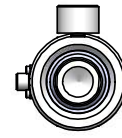

CEI.../...RO TO

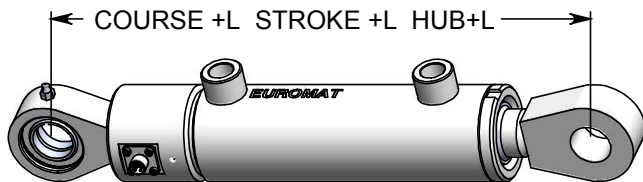
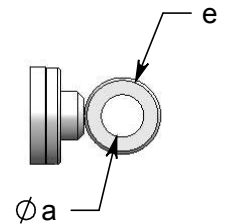
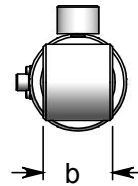

CEI.../...RO CM

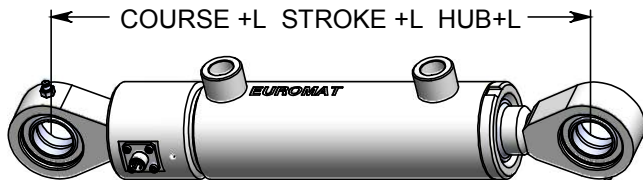
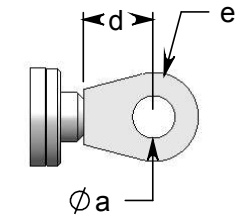
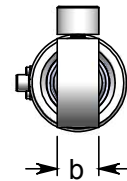

CEI.../...RO RO

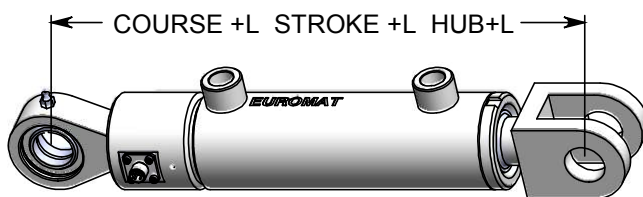
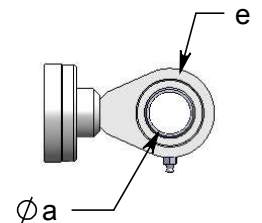
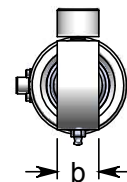

CEI.../...RO CF

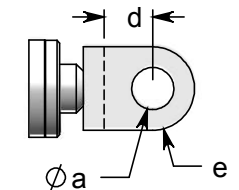
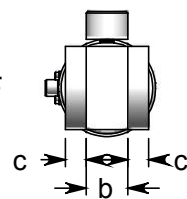

CEI.../... RO TF	DONNEES TECHNIQUES				TECHNICAL SPECIFICATIONS				TECHNISCHE ANGABEN			
a	60	60	60	70	70	80	80	100	100	125	125	
b	30	35	40	35	40	45	50	50	65	65	80	
c	70	70	70	80	80	90	90	115	115	140	140	
d	12	12	12	12	12	12	12	14	14	12	12	
e	3/8	3/8	3/8	3/8	3/8	3/8	3/8	1/2	1/2	1/2	1/2	
f	20	20	20	20	20	20	20	20	20	20	20	
g	0	0	0	0	0	0	0	0	0	0	0	
h	47	47	47	47	47	50	50	60	60	70	70	
i	19	19	19	19	19	19	19	19	19	19	19	
j	19	19	19	24	24	26	26	35	35	35	35	
k	32	32	32	32	32	40	40	47	47	60	60	
l	30	30	30	30	30	35	35	40	40	50	50	
m	30	30	30	30	30	35	35	40	40	50	50	
n	22	22	22	22	22	25	25	28	28	35	35	
p	50	50	50	50	50	60	60	70	70	85	85	
q	22	22	22	28	28	35	35	45	45	58	58	
r	22	22	22	28	28	35	35	45	45	58	58	
v	1,5	1,5	1,5	1,5	1,5	1,5	1,5	1,5	1,5	1,5	1,5	
L	265	265	265	270	270	290	290	290	290	325	325	

CEI.../... RO TT											
a	0	24	24	0	24	30	36	0	45	0	52
b	0	40	40	0	40	50	65	0	85	0	90
e		2	2		2	2	2		3		3
L	0	265	265	0	265	290	290	0	290	0	325

CEI .../... RO TO											
a	30	30	30	30	30	35	35	40	40	50	50
b	50	50	50	50	50	60	60	80	80	90	90
e	27,5	27,5	27,5	27,5	27,5	30	30	35	35	45	45
L	290	290	290	300	300	320	320	325	325	370	370

CEI .../... RO CM											
a	30	30	30	30	30	35	35	40	40	50	50
b	30	30	30	30	30	35	35	40	40	50	50
d	50	50	50	50	50	60	60	70	70	85	85
e	32	32	32	32	32	40	40	47	47	60	60
L	315	315	315	325	325	350	350	360	360	410	410

CEI .../... RO RO											
a	30	30	30	30	30	35	35	40	40	50	50
b	30	30	30	30	30	35	35	40	40	50	50
d	50	50	50	50	50	60	60	70	70	85	85
e	32	32	32	32	32	40	40	47	47	60	60
L	315	315	315	335	335	360	360	380	380	425	425

CEI .../... RO CF											
a	30	30	30	30	30	35	35	40	40	50	50
b	30	30	30	30	30	35	35	40	40	50	50
c	15	15	15	15	15	17,5	17,5	20	20	25	25
d	35	35	35	35	35	43	43	50	50	63	63
e	32	32	32	32	32	40	40	47	47	60	60
L	315	315	315	325	325	350	350	360	360	425	425